

## Edge Pull - Ref. 8001-100

Suitable for 18 mm thick profiles



### Product features

- solid brass edge pulls for use on drawers and various door types
- simple modern design that will compliment any style of furniture
- available in standard 50 mm, 75 mm, 100 mm and 200 mm sizes
- various finishes including standard and PVD

### Technical details

Attributes	Value
Knuckle diameter	17.0 mm
Overall length	100.0 mm
Screws	10.0 x 32.0 mm
Suitable profile size	18.0 mm

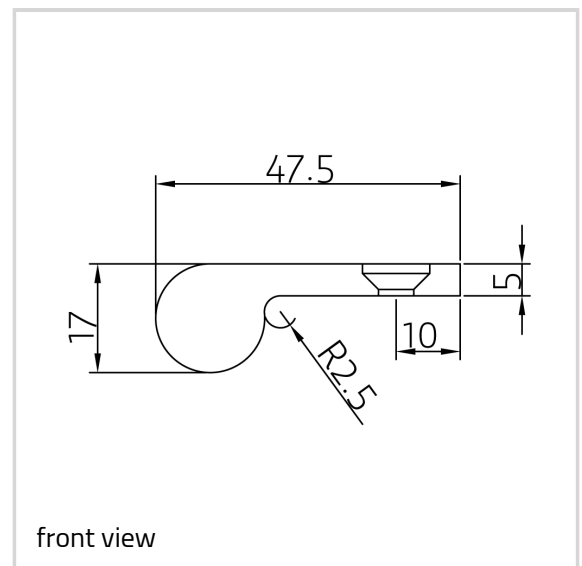

### Note

Supplied with brass Pozi-drive head woodscrews.

Bespoke length and sizes prices on application.

Salt spray tested to over 1,000 hours.

**Item**

Finish(es)	Aged Brass (UK 501)
OF-NR.	UK 501
VPE	Pack of 10
DIN	without
Item No.	8001-100.0
Finish(es)	Antique Brass (UK 502)
OF-NR.	UK 502
VPE	Pack of 10
DIN	without
Item No.	8001-100.0
Finish(es)	Antique nickel (UK 503)
OF-NR.	UK 503
VPE	Pack of 10
DIN	without
Item No.	8001-100.0
Finish(es)	Black nickel (UK 504)
OF-NR.	UK 504
VPE	Pack of 10
DIN	without
Item No.	8001-100.0
Finish(es)	Copper Bronze (UK 505)
OF-NR.	UK 505
VPE	Pack of 10
DIN	without
Item No.	8001-100.0
Finish(es)	Copper (UK 506)
OF-NR.	UK 506
VPE	Pack of 10
DIN	without
Item No.	8001-100.0
Finish(es)	Honeycombe (UK 507)
OF-NR.	UK 507
VPE	Pack of 10
DIN	without

**Hardware - Edge Pull - Ref. 8001-100**

Item No.	8001-100.0
Finish(es)	Imitation Bronze (UK 508)
OF-NR.	UK 508
VPE	Pack of 10
DIN	without
Item No.	8001-100.0
Finish(es)	Midnight (UK 509)
OF-NR.	UK 509
VPE	Pack of 10
DIN	without
Item No.	8001-100.0
Finish(es)	Pearl Nickel (UK 510)
OF-NR.	UK 510
VPE	Pack of 10
DIN	without
Item No.	8001-100.0
Finish(es)	Polished Chrome (UK 511)
OF-NR.	UK 511
VPE	Pack of 10
DIN	without
Item No.	8001-100.0
Finish(es)	Polished & Lacquered (UK 512)
OF-NR.	UK 512
VPE	Pack of 10
DIN	without
Item No.	8001-100.0
Finish(es)	Polished Nickel (UK 513)
OF-NR.	UK 513
VPE	Pack of 10
DIN	without
Item No.	8001-100.0
Finish(es)	Satin Brass & Lacquered (UK 514)
OF-NR.	UK 514
VPE	Pack of 10
DIN	without
Item No.	8001-100.0

**Hardware - Edge Pull - Ref. 8001-100**

Finish(es)	Satin Chrome (UK 515)
OF-NR.	UK 515
VPE	Pack of 10
DIN	without
Item No.	8001-100.0
Finish(es)	Satin nickel (UK 516)
OF-NR.	UK 516
VPE	Pack of 10
DIN	without
Item No.	8001-100.0
Finish(es)	PVD Brass (UK 517)
OF-NR.	UK 517
VPE	Pack of 10
DIN	without
Item No.	8001-100.0
Finish(es)	PVD Copper rose (UK 518)
OF-NR.	UK 518
VPE	Pack of 10
DIN	without
Item No.	8001-100.0
Finish(es)	PVD Matt black (UK 519)
OF-NR.	UK 519
VPE	Pack of 10
DIN	without
Item No.	8001-100.0
Finish(es)	PVD Rainbow (UK 520)
OF-NR.	UK 520
VPE	Pack of 10
DIN	without
Item No.	8001-100.0
Finish(es)	PVD Stainless steel effect (UK 521)
OF-NR.	UK 521
VPE	Pack of 10
DIN	without
Item No.	8001-100.0