

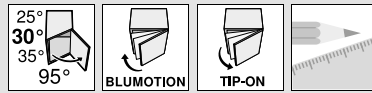

► **CLIP top BLUMOTION / CLIP top – hinges**
 ►► **Angled application – standard**



+30° II – angled hinge overlay



- **CLIP top BLUMOTION** with integrated **BLUMOTION** (with deactivation option)
- **CLIP top** without closing mechanism (spring)
- All metal hinge, nickel plated
- +30° II angled hinge
- 95° opening angle
- 3-dimensional front adjustment
- Convenient spiral-tech depth adjustment
- Tool-free door to cabinet assembly and removal
- With **INSERTA** tool-free hinge to door assembly

Webcode
DQDTDA

Page instructions			
Angled application	Angle		
	25°	30°	35°
	N° 20	N° 21	N° 22
	156	157	157
	N° 50	N° 51	N° 52
	156	157	157
	N° 5	N° 6	N° 7
	161	157	157
	N° 40	N° 41	N° 42
	158	158	158
	N° 57	N° 58	N° 59
	156	157	157
Overview – angled applications			148

Order information

Boss Hinge	INSERTA Spring	Part no.
CLIP top BLUMOTION	●	79B9596
● With spring	○ Unsprung	

Boss Hinge	Screw-on Spring	Part no.
CLIP top BLUMOTION	●	79B9556
CLIP top	○	78A9556.T

a Accessories		
Hinge arm cover cap		
Print/Stamp	Logo	Part no.
Plain	–	70.1553
Screen print	Blum	70.1553.BL

Hinge boss cover cap	
Hinge	Part no.
CLIP top BLUMOTION	70T3504
CLIP top	70T1504

TIP-ON for doors		
Version	Spring	Part no.
Short version	○	956.1004
Extended version	○	956A1004
Extended version	●	956A1006
● With spring	○ Unsprung	

Chipboard screws		
Ø (mm)	Length (mm)	Part no.
3.5	15	609.1500
3.5	17	609.1700

Note

CLIP top BLUMOTION and CLIP top hinges cannot be combined with each other on a front.

Page instructions

Overview – CLIP top BLUMOTION / CLIP top – hinges	107	Accessories – general	194	More technical details	774
Mounting plates	186	Overview – TIP-ON for doors	653		
Accessories – hinge arm cover cap	193	Assembly, removal and adjustment	196		
		Overview – assembly devices	683		

Planning

Note

These dimensions are based on a 19 mm thick door and cabinet. The application changes in cases of deviation. In these cases a trial is recommended. Some applications require the mounting plate to be moved from the standard fixing positions.

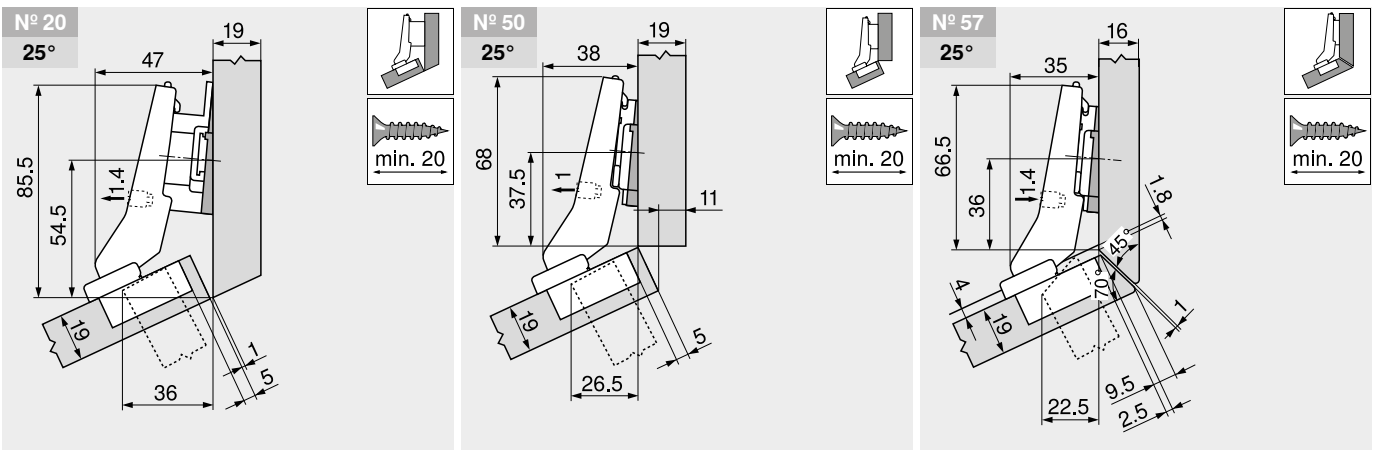

Description	Spacing (mm)	Part no.	Description	Spacing (mm)	Part no.	Description	Spacing (mm)	Part no.
Mounting plate	9	175H7190	Mounting plate	0	173H7100	Mounting plate	0	173H7100
Angled spacer	-5°	171A5500	Angled spacer	-5°	171A5500	Angled spacer	-5°	171A5500

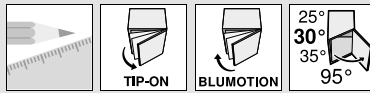

+30° II – angled hinge overlay

Webcode
 DQDTDA

Planning

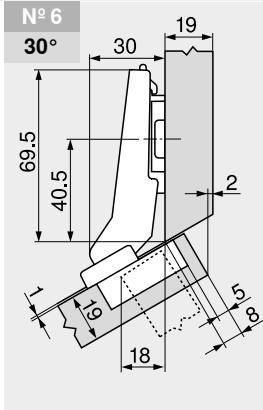
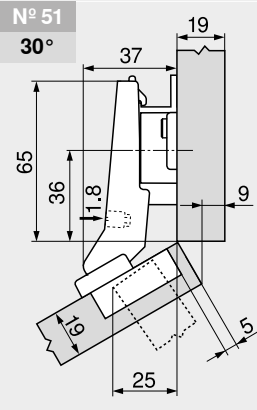
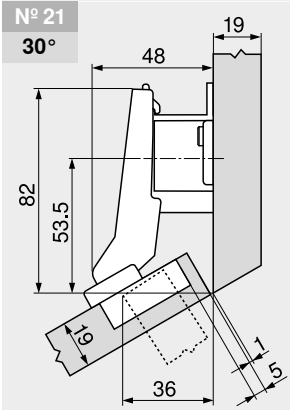

Description	Spacing (mm)	Part no.
Mounting plate	18	175H7190.22

Description	Spacing (mm)	Part no.
Mounting plate	9	175H7190

Description	Spacing (mm)	Part no.
Mounting plate	0	173H7100

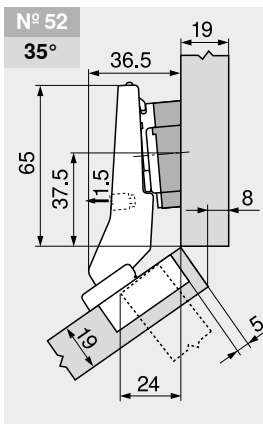
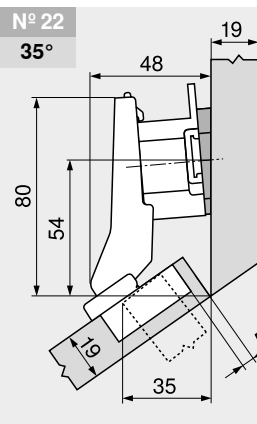
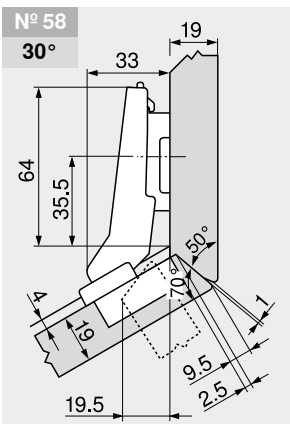

Description	Spacing (mm)	Part no.
Mounting plate	3	173H7130

Description	Spacing (mm)	Part no.
Mounting plate	18	175H7190.22
Angled spacer	+5°	171A5010

Description	Spacing (mm)	Part no.
Mounting plate	0	173H7100
Angled spacer	+5°	171A5070

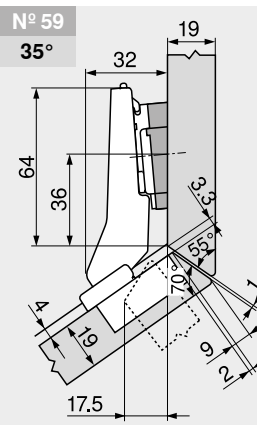
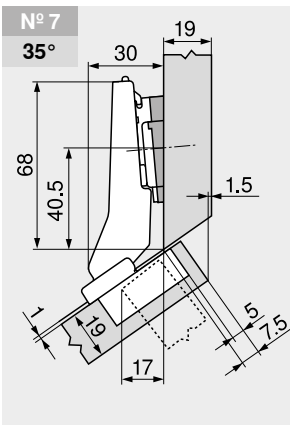

Description	Spacing (mm)	Part no.
Mounting plate	0	173H7100
Angled spacer	+5°	171A5010

Description	Spacing (mm)	Part no.
Mounting plate	0	173H7100
Angled spacer	+5°	171A5040

Adjustment

Max. ±3.0 mm See mounting plates	±1.8 mm	±2.0 mm
-------------------------------------	---------	---------

Page instructions
 Hinge boss fixing **159**