

Product details

TANDEMBOX drawer side, height K (115 mm), NL=450 mm, right+left, for TANDEMBOX antaro

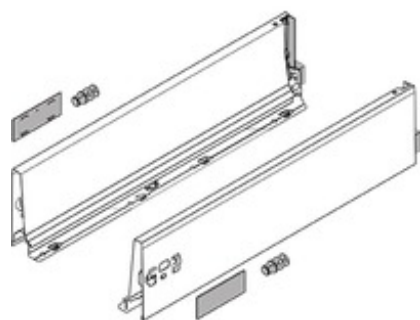

Part number	378K4502SA
Item number	07800942
Colour / finish	RAL 9006 grey (white aluminium)
Packaging quantity	1 / 6
Weight per 1,000 Pcs in kg	1,815.62
EAN code	9009494103304
UPC code	

Technical attributes

Attribute	Value
type of Box	TANDEMBOX drawer side
Material	Steel
Drawer side height	K (115 mm)
Design	A
Nominal Length	450
connection drawer side to frontal	ZSF-front fixing bracket clip on with crash damping
connection drawer side to back	Clip on (steel back or wooden back fixing bracket)
length of drawer side hat (internal drawer length)	440
install.dim.drawer side(inn.carc.depth till outer base edge)	37.5
Height adjustment	+/- 2 mm
fixing of base to drawer side	prong connection or screw-on
Bottom thickness	16
finish of drawer side	RAL 9006 grey (white aluminium)
finish of back fixing bracket	RAL 7037 dust grey
stay-open stop	No
minimum internal cabinet depth	453
Additional features	Easy height adjustment via cam
additions	T54.330 positioning dowel, enclosed
additions	ZAA.532-C1.BT white grey cover caps, enclosed
Item package	right+left
packaging	Commercial packing
drawer type	Full extension