

BUTTERFLY HOOK

TEST METHOD

LOAD CAPACITY
3~6 kg
6~13 lbs

4x12
STAINLESS

STAINLESS
304
STEEL

TZ-360

- Hinged flap allows flush or corner mount.
- Applicable angle: 90°~ 270°

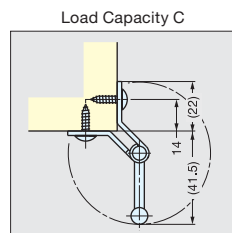
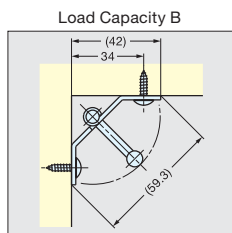
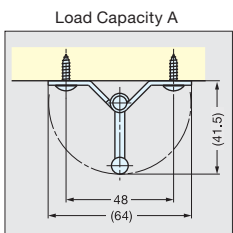
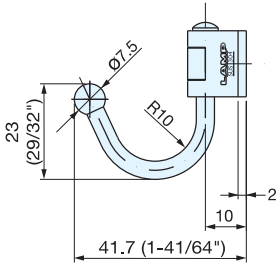
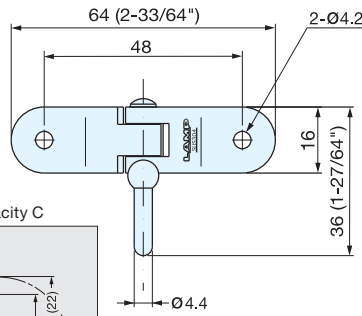
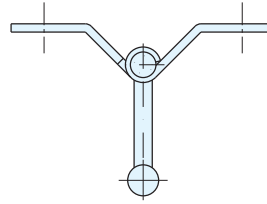

Installation

Material	Finish
304 Stainless Steel	Polished

Item No.	Load Capacity A (kg)	Load Capacity B (kg)	Load Capacity C (kg)	Weight (g)	Box (pcs)	Carton (pcs)
TZ-360	6 (13 lbs)	5.6 (12 lbs)	3 (6 lbs)	27	50	500

BUTTERFLY HOOK

4x12
STAINLESS

STAINLESS
304
STEEL

DZ-270

- Hinged flap allows flush or corner mount.
- Applicable angle: 90°~ 270°

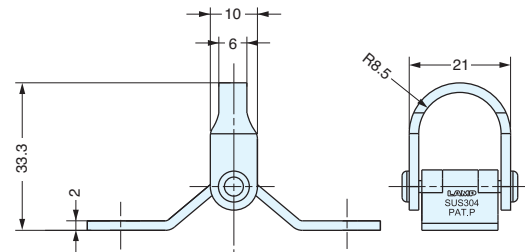
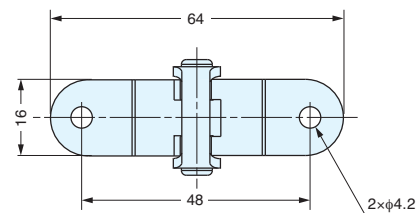

Material	Finish
304 Stainless Steel	Polished

Item No.	Load Capacity (kg)	Weight (g)	Box (pcs)	Carton (pcs)
DZ-270	-	29	50	500